

Valve manifold for differential pressure measuring instruments

3-, 5-valve manifold

Models IV30, IV31, IV50 and IV51

WIKA data sheet AC 09.23

EAC

Applications

- Shut-off, pressure compensating, purge and vent valves for differential pressure measuring instruments
- For gaseous and liquid aggressive media that are not highly viscous or crystallising, also in aggressive environments
- Process industry: Oil & gas, petrochemical, chemical industries, power generation, water and wastewater

Special features

- Low-wear design due to non-rotating spindle tip in the bonnet
- Low torque and smooth operation of valve handle even at high pressure
- Enhanced safety due to blow-out proof bonnet design
- Customer-specific combination of valves and instruments (hook-up) on request
- Standardised centre distances of 37 mm and 54 mm, suitable for WIKA differential pressure gauges and commonly used process transmitters

Description

3-valve manifold, models IV30 and IV31

The 3-valve manifold consists of two shut-off valves and one pressure compensating valve. The shut-off valves separate the process from the differential pressure measuring instrument. The pressure compensating valve enables the compensation between \oplus side and \ominus side to avoid one-sided overpressure during commissioning and operation.

5-valve manifold, models IV50 and IV51

Compared to the 3-valve manifold, the 5-valve manifold is equipped with two additional vent valves. One vent valve per pressure side allows operators the targeted venting of one or both pressure sides of the measuring arrangement.

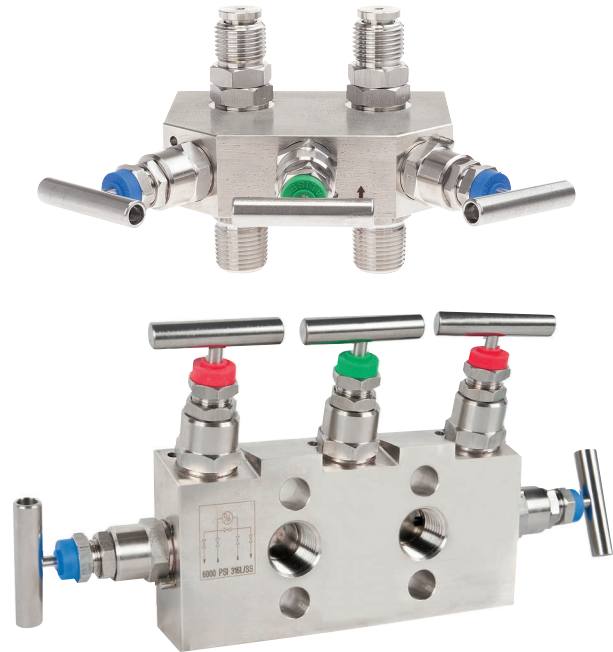

Fig. top: Model IV31, 3-valve manifold

Fig. bottom: Model IV51, 5-valve manifold

Through the non-rotating spindle tip, the wear of the sealing elements is reduced. This results, particularly with frequent opening and closing, in a noticeable increase in the service life.

Through the blow-out proof design of the valve, working safety is improved, especially in applications with high pressure loading.

As an option, WIKA offers the professional assembly of valves and pressure measuring instruments and also other accessories into a ready-to-install solution, also known as a hook-up. To ensure the performance of the complete system, an additional leak test is carried out on the hook-up.

Specifications

Valve manifold, models IV30, IV31, IV50 and IV51	
Standards used	
Design	<ul style="list-style-type: none"> ■ ASME B16.34, valves - flanged, threaded and welding end ■ ASME B1.20.1, pipe threads, general purpose (inch) ■ MSS SP-99, valves for measuring instruments
Tests	<ul style="list-style-type: none"> ■ API 598, valve inspection and testing ■ ISO 5208, pressure testing of metallic valves with leakage rate A ■ MSS SP-61, pressure testing of valves
Material requirements	<ul style="list-style-type: none"> ■ NACE MR0175 / ISO 15156, use in H₂S-containing environments in oil and gas production ■ NORSOK M-630, specification for use in pipelines (Norway)
Marking	MSS SP-25, marking on valves
Valve position (dimensions see page 6 ff.)	<ul style="list-style-type: none"> ■ Angled, pressure compensating valve in front, other valves arranged laterally ¹⁾ ■ Radial, valves arranged side-by-side ²⁾ ■ Angled, for direct flange mounting ²⁾
Process connection / instrument connection	<ul style="list-style-type: none"> ■ ½ NPT female / G ¼ pressure screw ■ ½ NPT male / G ¼ pressure screw ■ ½ NPT female / G ½ pressure screw ■ ½ NPT male / G ½ pressure screw ■ ½ NPT female / process connection per IEC 61518 form B ■ ¼ NPT female / process connection per IEC 61518 form B
Vent connection	¼ NPT female, plug screw is included in delivery, though not pre-fitted
Mounting	<ul style="list-style-type: none"> ■ Without mounting holes ■ Suitable for mounting bracket, with mounting holes
Bonnet design (see page 4 ff.)	<ul style="list-style-type: none"> ■ Standard version ■ Extended handle version
Bonnet options	<ul style="list-style-type: none"> ■ Without ■ Anti-tamper version without padlock, vent ■ Anti-tamper version without padlock, shut off and vent ■ Small T-bar handle ■ T-bar handle from stainless steel 316L
Padlock ⁶⁾	<ul style="list-style-type: none"> ■ Without ■ With padlock, vent ■ With padlock, shut off ■ With padlock, compensate ■ With padlock, vent and compensate ■ With padlock, shut off, vent and compensate
Special design feature	<ul style="list-style-type: none"> ■ Without ■ For oxygen, oil and grease free

1) Option only for models IV30 and IV50

2) Option only for models IV31 and IV51

Functional diagram

3-valve manifold

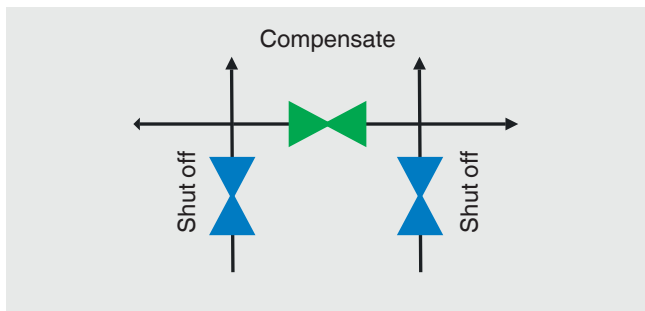

5-valve manifold

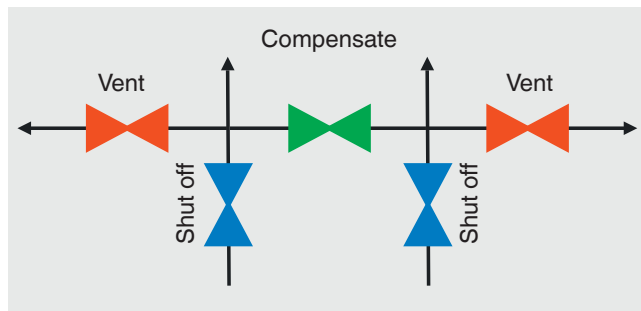

Material

Wetted parts

Valve body	<ul style="list-style-type: none"> ■ Stainless steel 316/316L (standard) ■ Monel 400 ■ Hastelloy 276 ■ Others on request
Bonnet body	
Spindle tip	
Sealing packing	<ul style="list-style-type: none"> ■ PTFE (standard) ■ Graphite ■ RTFE <p>Reinforced PTFE, material for optional certificate "Emission protection in accordance with TA-Luft (VDI 2440) and ISO-15848-1"</p>

Non-wetted parts

Gland nut, valve spindle, seal bush, locking nut, locking pin	Stainless steel 316L
Handle	<ul style="list-style-type: none"> ■ Stainless steel (standard) ■ Stainless steel 316/316L

Bonnet, standard version

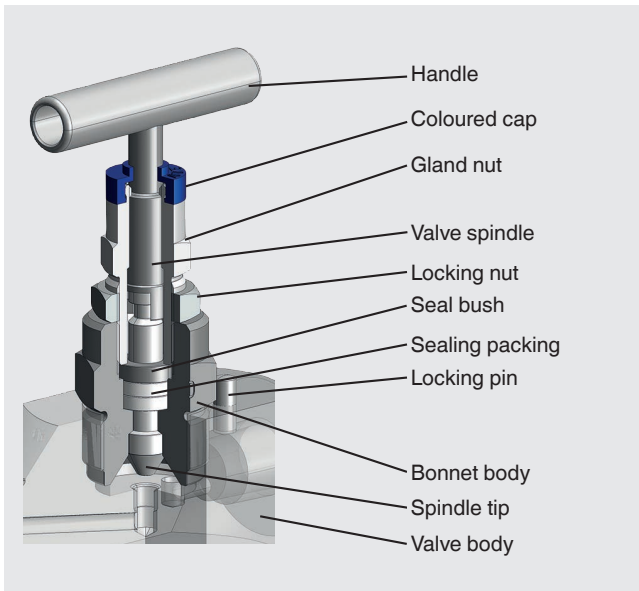

Specifications

Standards complied with	<ul style="list-style-type: none"> ASME VIII div. 1 and MSS SP-99 TA-Luft (VDI 2440) and ISO-15848-1 (option)
Dust cap colour code	<ul style="list-style-type: none"> Blue: Shut off Red: Vent Green: Compensate
Spindle tip	Non-rotating, low-wear, blow-out-safe
Valve seat	Metal-to-metal, back seat design
Valve bore size	4 mm [0.16 in]

Anti-tamper version



Anti-tamper version with padlock

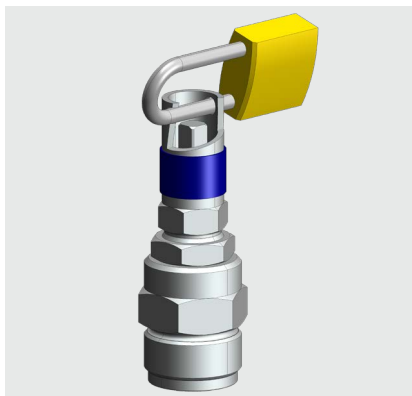

Extended handle version



Accessory: Anti-tamper key



Pressure-temperature diagram

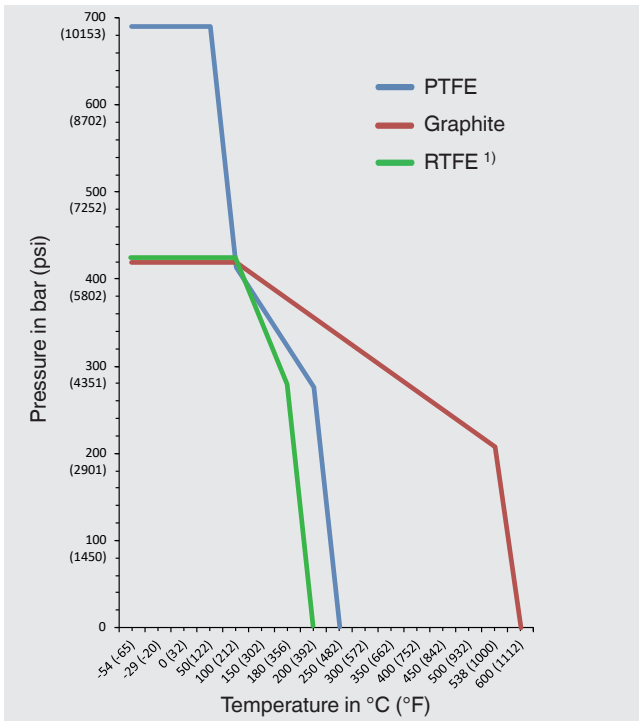

Material of the sealing packing	Max. permissible operating pressure in bar at temperature in °C	Max. permissible operating pressure in psi at temperature in °F
PTFE	690 bar at 38 °C	10,000 psi at 100 °F
	276 bar at 204 °C	4,000 psi at 400 °F
Graphite	420 bar at 38 °C	6,000 psi at 100 °F
	209 bar at 538 °C	3,030 psi at 1.000 °F
RTFE 1)	420 bar at 38 °C	6,000 psi at 100 °F
	276 bar at 180 °C	4,000 psi at 356 °F

1) Reinforced PTFE, material for optional certificate „Emission protection in accordance with TA-Luft (VDI 2440) and ISO-15848-1

The minimum design temperature is -54 °C [-65 °F].

For continuously low operating temperatures ≤ -54 °C [≤ -65 °F] a special design is needed.

Dimensions in mm [in]

3-valve manifold, model IV304, centre distance on instrument side: 37 mm [1.45 in]

Valve position: Angled, pressure compensating valve in front, other valves arranged laterally

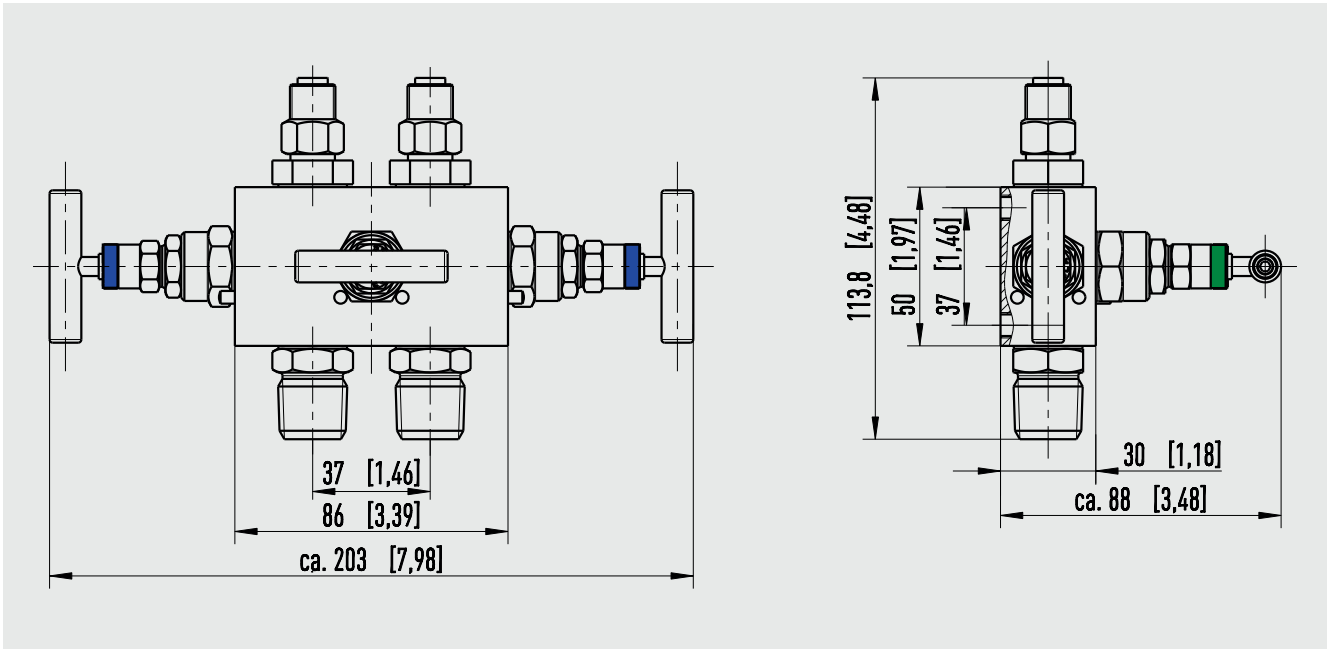

For differential pressure gauge, WIKA model 732.51

3-valve manifold, model IV315, centre distance on instrument side: 54 mm [2.12 in]

Valve position: Radial, valves arranged side-by-side

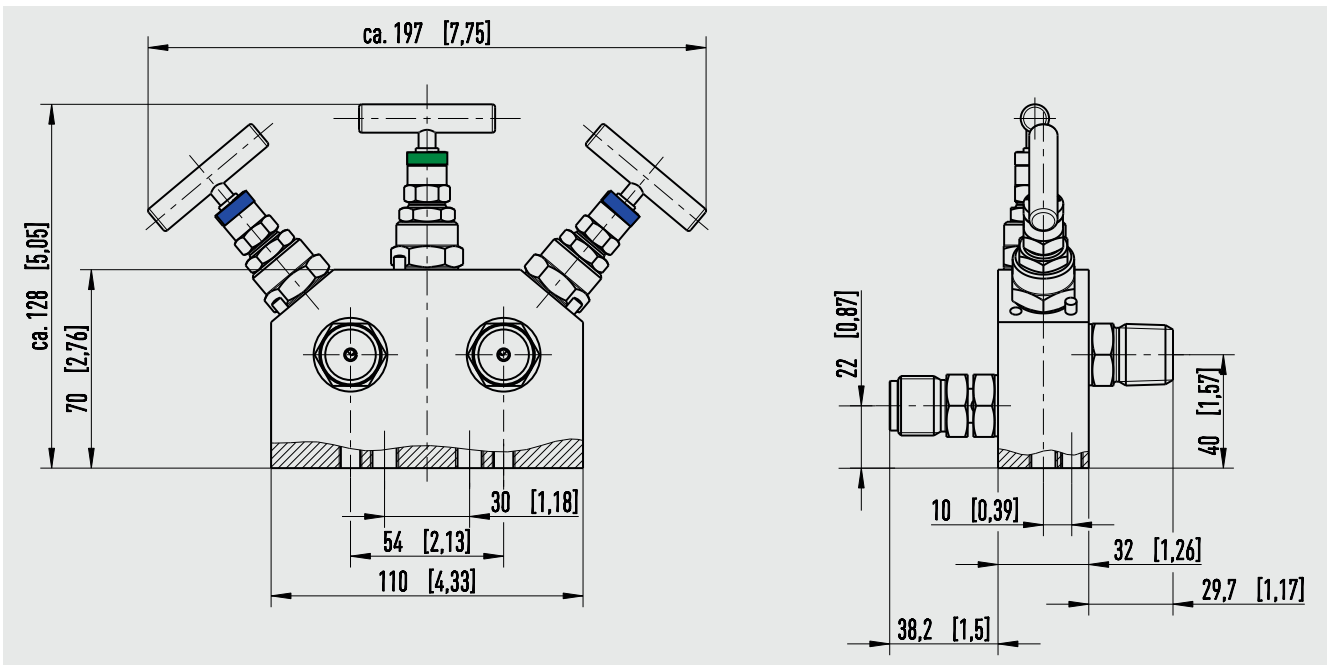

For differential pressure gauges, WIKA model 732.14

3-valve manifold, model IV316, centre distance on instrument side: 54 mm [2,12 in]

Valve position: Angled, for direct flange mounting

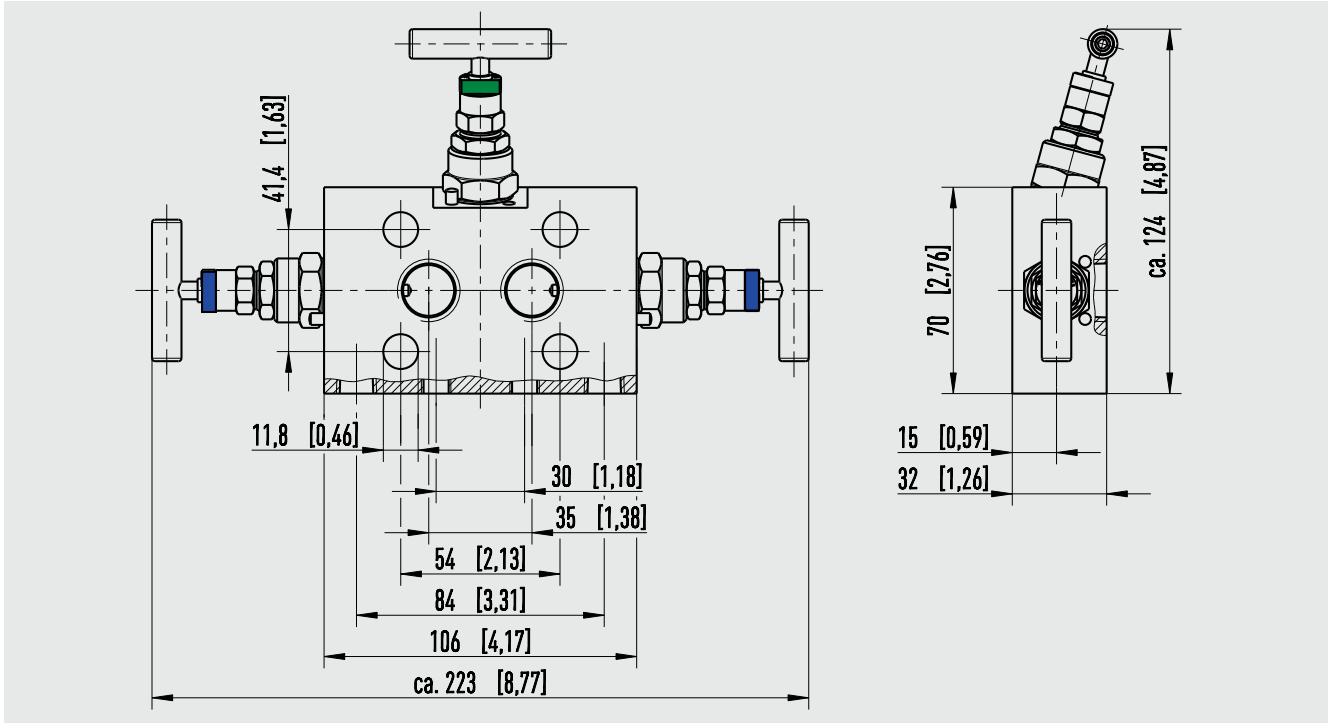

For differential pressure measuring instruments with process connection per IEC 61518 form A or form B
 Form B: E.g. for differential pressure gauges, WIKA model 732.14, with process connection per IEC 61518
 Form A: E.g. for transmitters, WIKA model DPT-10

5-valve manifold, model IV504, centre distance on instrument side: 37 mm [1.45 in]

Valve position: Angled, pressure compensating valve in front, other valves arranged laterally

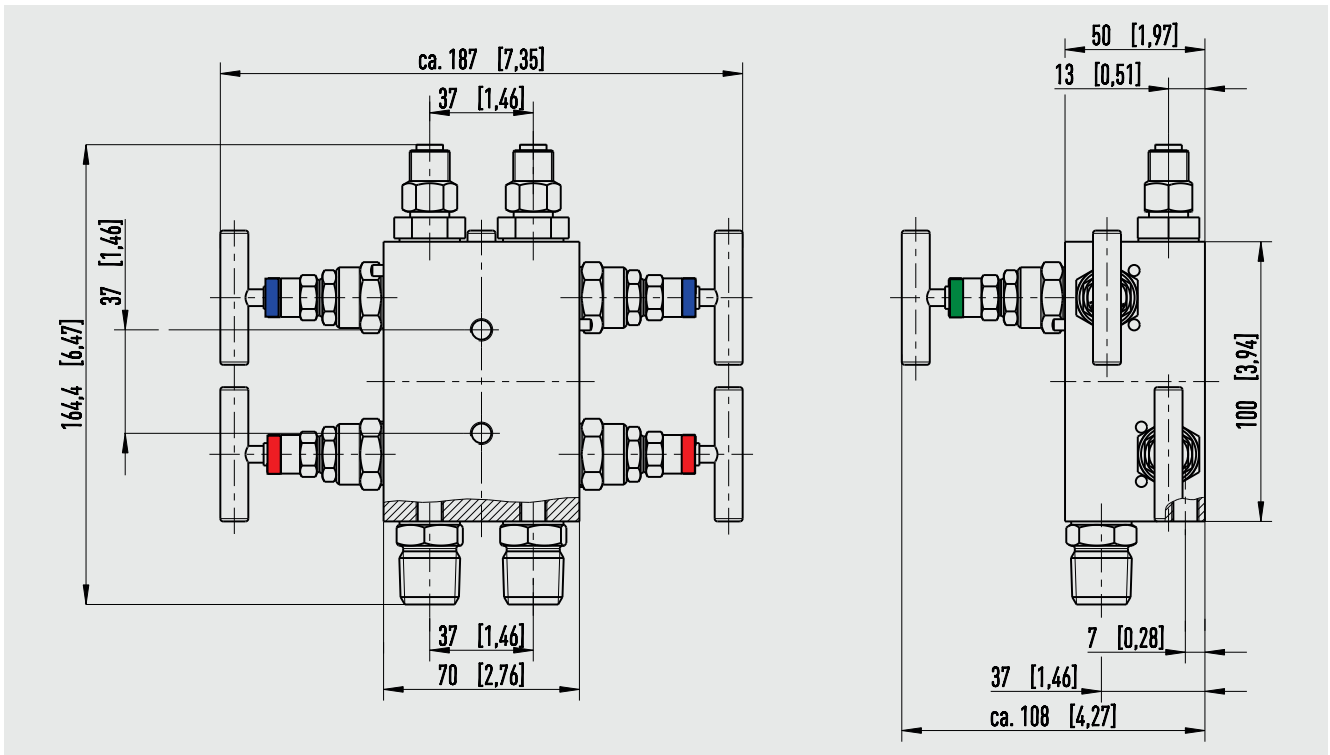

For differential pressure gauge, WIKA model 732.51

5-valve manifold, model IV515, centre distance on instrument side: 54 mm [2.12 in]

Valve position: Radial, valves arranged side-by-side

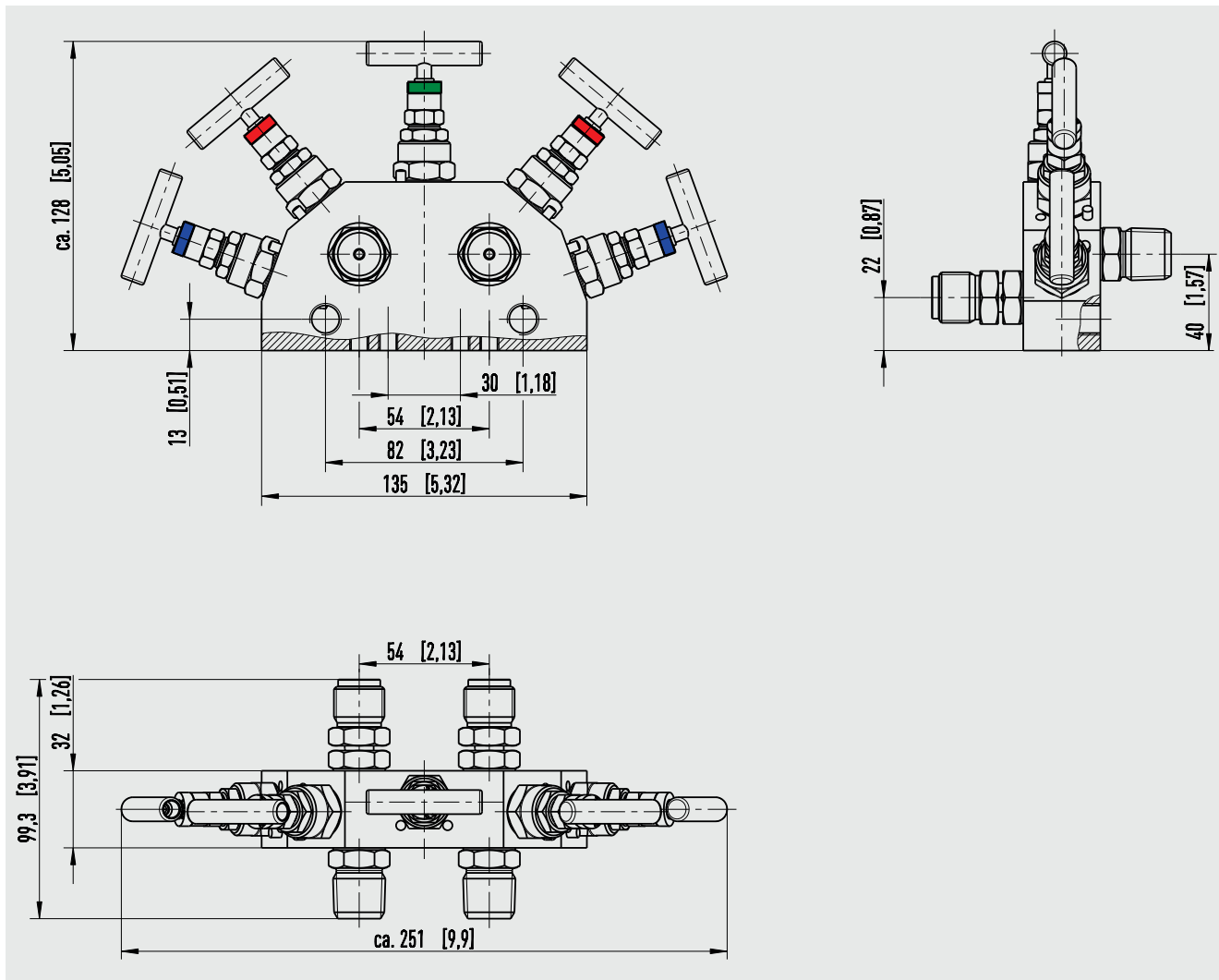

For differential pressure gauges, WIKA model 732.14

5-valve manifold, model IV516, centre distance on instrument side: 54 mm [2,12 in]

Valve position: Angled, for direct flange mounting

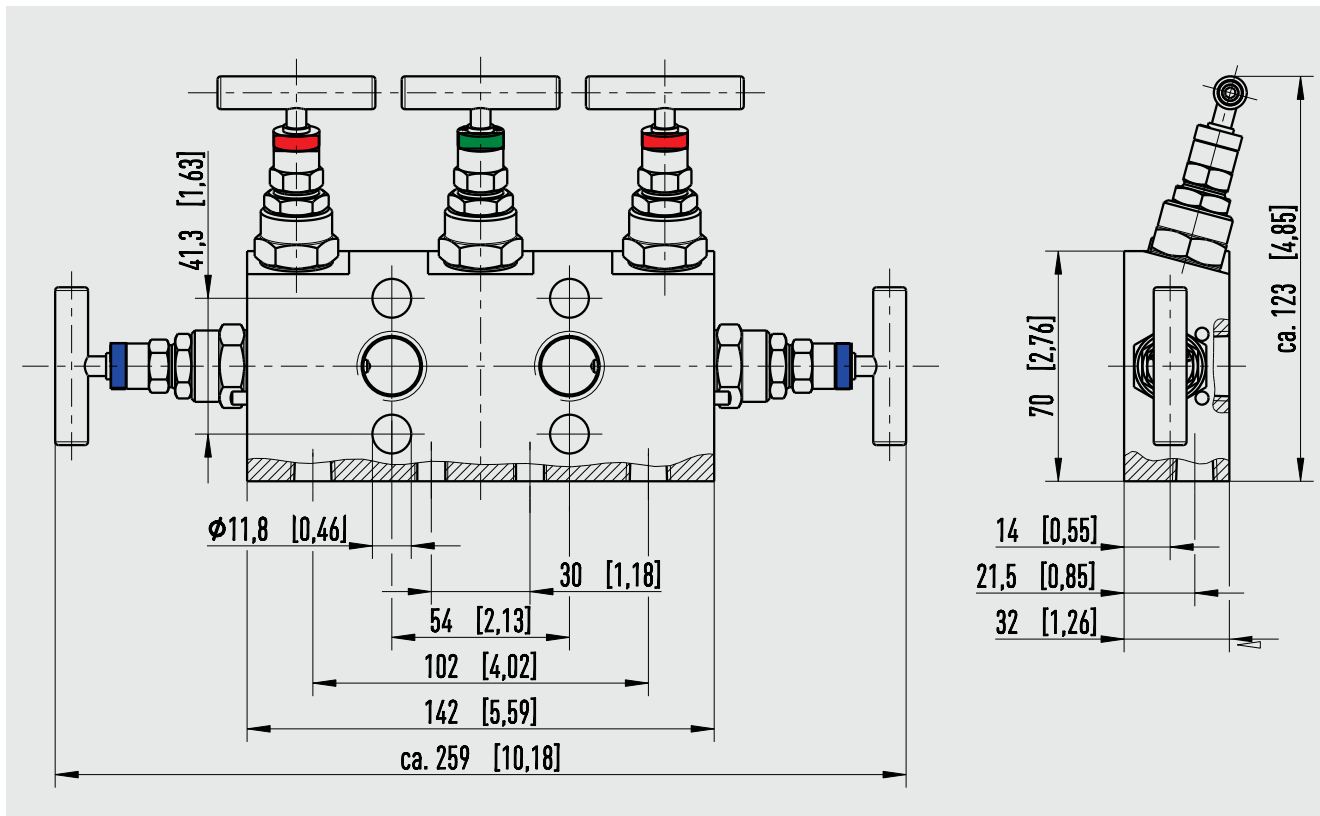

For differential pressure measuring instruments with process connection per IEC 61518 form A or form B
Form B: E.g. for differential pressure gauges, WIKA model 732.14, with process connection per IEC 61518
Form A: E.g. for transmitters, WIKA model DPT-10

Accessories

Only for versions with mounting option "R": Suitable for mounting bracket, with mounting holes

Scope of delivery: 1 mounting bracket, 2 U-bolts, 2 screws for valve mounting

Material: Stainless steel

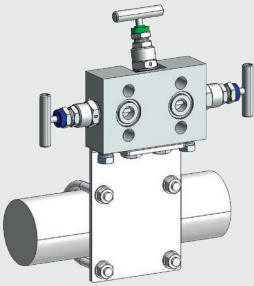
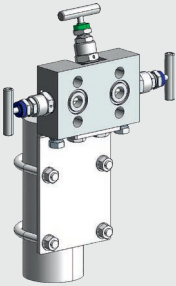
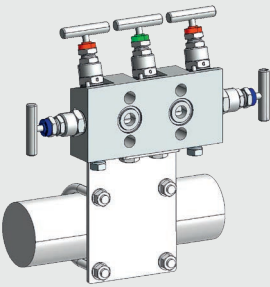
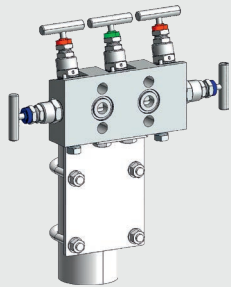
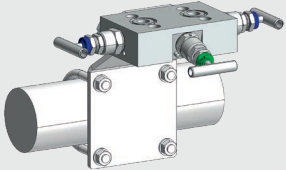
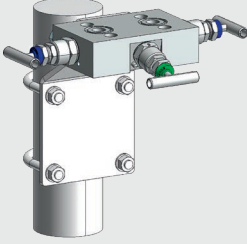
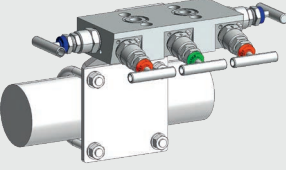
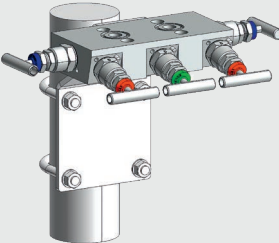
Mounting bracket with mounting material				
For model	Centre distance on instrument side	Alignment of the pipeline		Order number
		Horizontal	Vertical	
IV31	54 mm [2,12 in]			14267553
IV51	54 mm [2,12 in]			14267553
IV31	54 mm [2,12 in]			14289800
IV51	54 mm [2,12 in]			14289800

Approvals

Logo	Description	Country
	EAC (option)	Eurasian Economic Community
-	CRN	Canada

Manufacturer's information and certificates

Logo	Description
-	PMI ¹⁾ test certificate (option) Valve body
-	Certificate for oxygen versions (option) - Oil and grease free for oxygen per ASTM G93 level C - Sealing packing and lubricants in accordance with BAM requirements - Limits of the permissible operating ranges for pressure and temperature: 420 bar at 60 °C or 6,000 psi at 140 °F 90 bar at 200 °C or 1,305 psi at 392 °F
-	Emission protection in accordance with TA-Luft (VDI 2440) and ISO-15848-1 (option) - Tightness class: AH - Endurance class: C01 - Temperature class: -29 ... +180 °C [-20 ... +356 °F]

1) Positive material identification

Certificates

- 3.1 inspection certificate per EN 10204
 - Material certificate for the valve body per NACE (MR0103/MR0175)
 - Confirmation of pressure tests per API 598 ²⁾
- 3.1 inspection certificate per EN 10204 (option)
 - Material certificate for all wetted parts per NACE (MR0103/MR0175)
 - Confirmation of pressure tests per API 598 ²⁾

2) Shell test: 15 s test duration with 1.5 times the permissible working pressure
Seat test: 15 s test duration with 1.1 times the permissible working pressure

© 02/2018 WIKA Alexander Wiegand SE & Co. KG, all rights reserved.
The specifications given in this document represent the state of engineering at the time of publishing.
We reserve the right to make modifications to the specifications and materials.

